











NOVA Wood multipurpose tables

CABLE MANAGEMENT GUIDELINES



! All electrical installations should be done by a qualified person in accordance with local regulation.

- Electric power limits, of how much power sockets can be plugged into one mains socket, without overloading it, varies from country. Read the following information!

Market	Plug / Power cable	Power socket type	Max power (V x A)	Recommended / Legal maximum number of sockets fed from 1 plug	National standard	OCP* requirement
EU	Type E (16A)  To GST18i3 Female Cable core 1,5mm ²	Type F  Schuttered Schuko (German)	230V x 16A = 3680W	Maximum of 8 power sockets would be considered as safe and reasonable limit on a same shared circuit. More sockets (10-16) would be possible if on a dedicated circuit intended to use only office equipment such as laptops, tablets, phone chargers (less than 200W). Although this fully depends on the load of the equipment on a circuit as whole.	N/A	N/A
FR	Type E (16A)  To GST18i3 Female Cable core 1,5mm ²	Type E  French/Belgian	230V x 16A = 3680W	Maximum of 8 power sockets would be considered as safe and reasonable limit on a same shared circuit. More sockets (10-16) would be possible if on a dedicated circuit intended to use only office equipment such as laptops, tablets, phone chargers (less than 200W). Although this fully depends on the load of the equipment on a circuit as whole.	N/A	N/A
UK	Type G (13A)  To GST18i3 Female Cable core 1,5mm ²	Type G  UK socket Fused (3,15A)	230V x 13A = 2990W	Maximum 6 fused (3,15A) power sockets can be fed from single starter cable in office and education environments.	BS 6396:2008+A1:2015 Electrical systems in office furniture and educational furniture	N/A
CH	Type J (10A)  To GST18i3 Female Cable core 1,5mm ²	Type J  Swiss socket	230V x 10A = 2300W	Maximum of 6 power sockets would be considered as safe and reasonable limit on a same shared circuit. More sockets (8-10) would be possible if on a dedicated circuit intended to use only office equipment such as laptops, tablets, phone chargers (less than 200W). Although this fully depends on the load of the equipment on a circuit as whole.	SEV 1011 Swiss national standard for plugs and sockets for domestic use and similar purposes	For units hardwired to a plug with 2 or more sockets being fed from it (10A OCP)
US	Type B (15A)  To GST18i3 Female Cable core 14AWG	Type B  NEMA 5-15P	120V x 15A = 1800W	Maximum of 8 power sockets can be fed from single starter cable in office and education environments.	UL 962A UL STANDARD FOR SAFETY Furniture Power Distribution Units	For units hardwired to a plug with 4 or more sockets being fed from it (15A OCP – 14AWG cable)
EU FR UK CH US	Cable core 1mm ² (European markets) Cable core 18AWG (US market)	Type A+C (25W)  Twin USB fast charger	3680W 3680W 2990W 2300W 1800W	EU – max 30 sockets FR – max 30 sockets UK – max 30 sockets CH – max 20 sockets US – max 20 sockets	UL62368-1 Standard for Audio/ video, information and communication technology equipment Part 1: Safety requirements	N/A

*Over Current Protection. Read the following information.

STARTER CABLES WITH OCP

Over current protection (OCP) fulfills statutory requirements:

- For USA for more than 3 sockets (UL 962A);
- For Switzerland for more than 1 socket (SEV 1011).

OCP device is hardwired into starter cables and designed to open the internal contacts in the event of a current flow in excess of the rated current according to its time/current characteristics. This protects the device from damage, should a surge occur. It can also provide loadside protection to devices that are connected to higher rated supply side circuits.

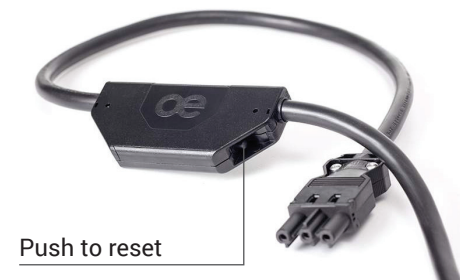

A thermo bimetallic strip, which has the advantage of being immune to high inrush currents and line transients, is heated by over current and deflects thereby releasing the latch mechanism. The contacts open even if the reset button is manually held in the closed position. This is known as trip-free mechanism. The contacts open and close with a positive snap action and the tripped state is clearly indicated by the extended projection of the reset button.

CONVENIENT WIRE MANAGEMENT

The metal frame of table (1), cable tray (2), and VESA holder (3) have special cut-outs designed for convenient horizontal wire management, therefore, there is no need to purchase extra accessories.

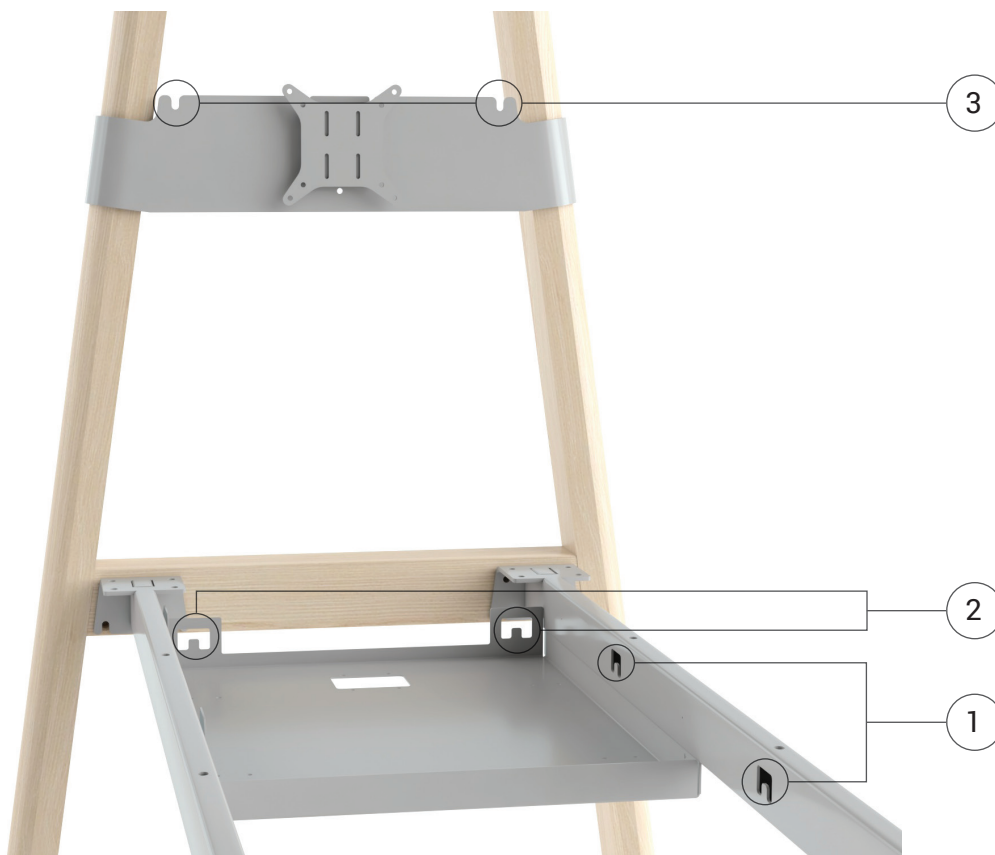



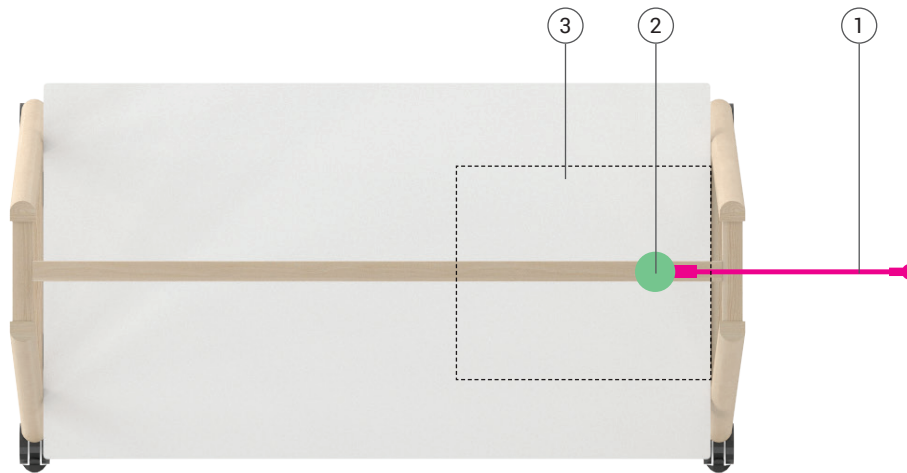

There are many solutions of how to manage electric power cables with GST18i3 connectors. See below a few of the examples.

ORDERING EXAMPLE 1



Pricelist item's selection







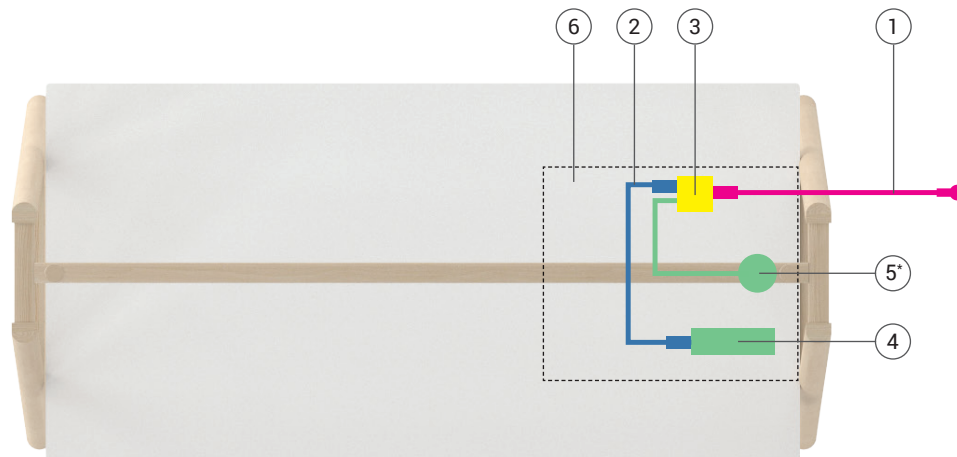

	Description	Code	Quantity
1	 Power supply cable	EU, UK, FR: ZZZ346 or ZZZ347 CH: ZCH001 or ZCH002 US: ZUS049 or ZUS050	1 pc.
2	 AC power socket and integrated USB fast charger type-A and type-C	ARU704	1 pc.
3	 Cable tray*	DNZ045	1 pc.
	 Cable duct (plastic) with metal base, L=750 mm	DOZ006	1 pc.
	 Multipurpose table with cut out for power socket and castors	DHH16D	1 pc.

*Make sure that before relocating your table with castors, all electrical components are disconnected from the main power source and stacked into a cable tray.

ORDERING EXAMPLE 2









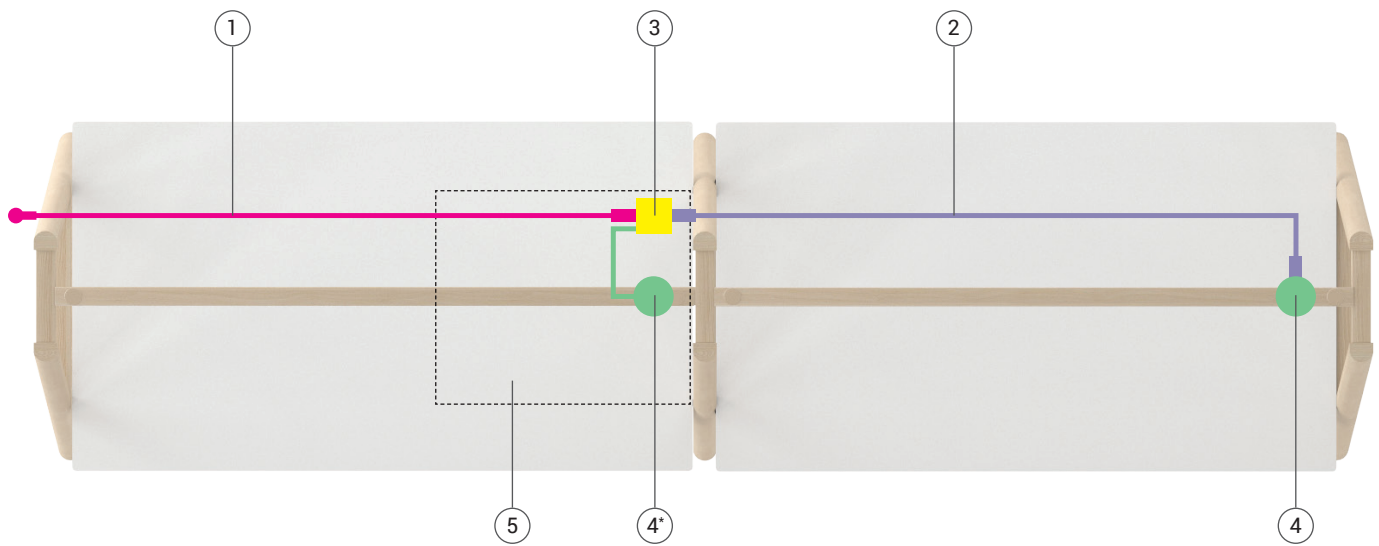

Pricelist item's selection

	Description	Code	Quantity
1	 Power supply cable	EU, UK, FR: ZZZ346 or ZZZ347 CH: ZCH001 or ZCH002 US: ZUS049 or ZUS050	1 pc.
2	 Extension cable GST18i3 male - GST18i3 female, 1 m	EU, UK, FR, CH: ZZZ348 US: ZUS051	1 pc.
3	 Distributor block GST18i3 (1 IN, 2 OUT)	ZZZ366	1 pc.
4	 Power unit (3 x AC power sockets)	ZZZ355	1 pc.
5	 AC power socket and integrated USB fast charger type-A and type-C * Hardwired with 800 mm lead to male GST18i3, OE Electrics	ARU704	1 pc.
6	 Cable tray	DNZ045	1 pc.
	 Cable duct (plastic) with metal base, L=1250 mm	DOZ005	1 pc.
	 Multipurpose table with cut out for power socket (High)	DHH185	1 pc.

ORDERING EXAMPLE 3









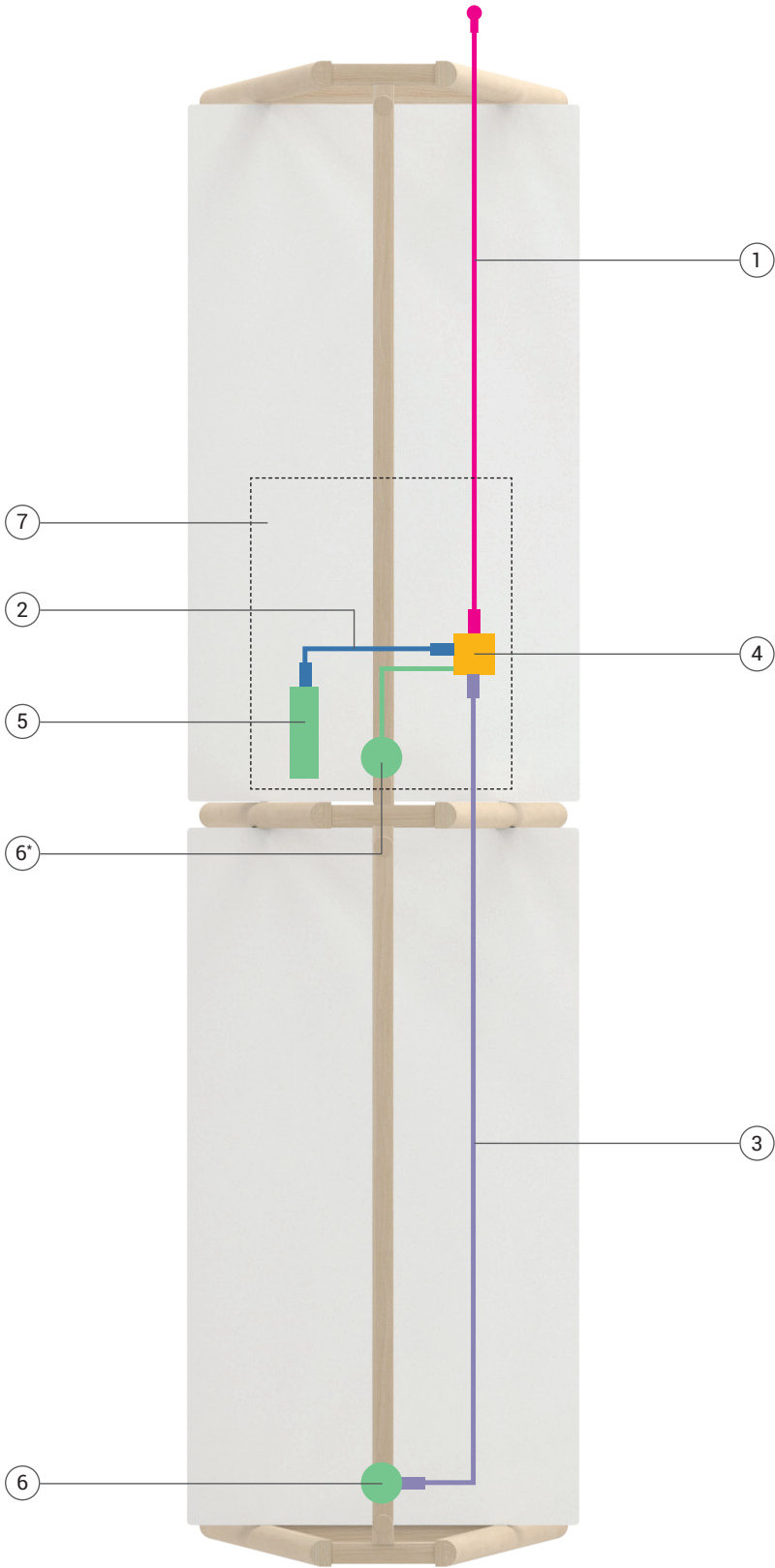



Pricelist item's selection

	Description	Code	Quantity
1	 Power supply cable	EU, UK, FR: ZZZ346 or ZZZ347 CH: ZCH001 or ZCH002 US: ZUS049 or ZUS050	1 pc.
2	 Extension cable GST18i3 male - GST18i3 female, 3 m	EU, UK, FR, CH: ZZZ350 US: ZUS053	1 pc.
3	 Distributor block GST18i3 (1 IN, 2 OUT)	ZZZ366	1 pc.
4	 AC power socket and integrated USB fast charger type-A and type-C <small>* Hardwired with 800 mm lead to male GST18i3, OE Electrics</small>	ARU704	2 pcs.
5	 Cable tray	DNZ045	1 pc.
	 Cable duct (plastic) with metal base, L=1250mm	DOZ005	1 pc.
	 Multipurpose table with cut out for power socket (High)	DHH164	1 pc.
	 Multipurpose table supplementary unit with cut out for power socket (High)	DHE16E	1 pc.

ORDERING EXAMPLE 4





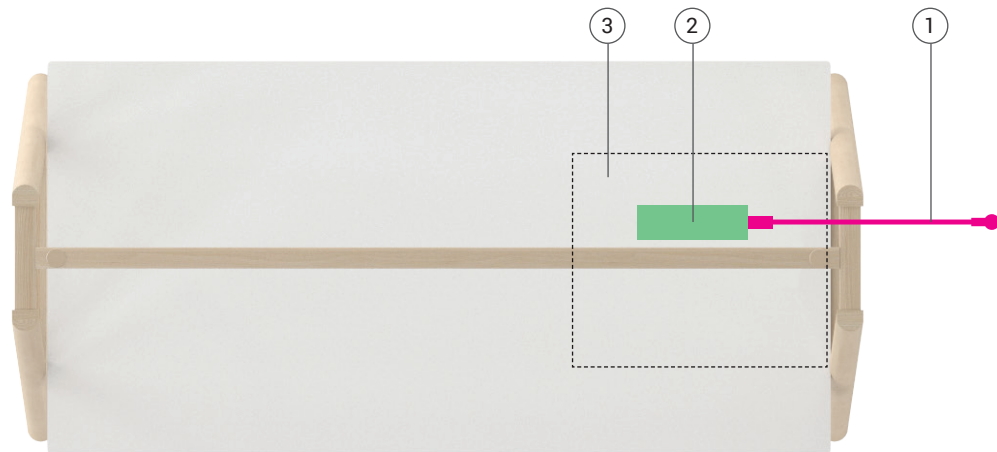

Pricelist item's selection

	Description	Code	Quantity
1	 Power supply cable	EU, UK, FR: ZZZ346 or ZZZ347 CH: ZCH001 or ZCH002 US: ZUS049 or ZUS050	1 pc.
2	 Extension cable GST18i3 male - GST18i3 female, 1 m	EU, UK, FR, CH: ZZZ348 US: ZUS051	1 pc.
3	 Extension cable GST18i3 male - GST18i3 female, 3 m	EU, UK, FR, CH: ZZZ350 US: ZUS053	1 pc.
4	 Distributor block GST18i3 (1 IN, 3 OUT)	ZZZ367	1 pc.
5	 Power unit (3 x AC power sockets)	ZZZ355	1 pc.
6	 AC power socket and integrated USB fast charger type-A and type-C <small>* Hardwired with 800mm lead to male GST18i3, OE Electrics</small>	ARU704	2 pcs.
7	 Cable tray	DNZ045	1 pc.
	 Cable duct (plastic) with metal base, L=1250 mm	DOZ005	1 pc.
	 Table Multipurpose table with cut out for power socket (High)	DHH164	1 pc.
	 Multipurpose table supplementary unit with cut out for power socket (High)	DHE16E	1 pc.

ORDERING EXAMPLE 5



Pricelist item's selection

	Description	Code	Quantity
1	 Power supply cable	EU, UK, FR: ZZZ346 or ZZZ347 CH: ZCH001 or ZCH002 US: ZUS049 or ZUS050	1 pc.
2	 Power unit (3 x AC power sockets)	ZZZ355	1 pc.
3	 Cable tray	DNZ045	1 pc.
	 Cable duct (plastic) with metal base, L=750mm	DOZ006	1 pc.
	 Multipurpose table	DHH180	1 pc.